



Modular Cooking Range Line thermaline 85 - 4-Burner Gas Top, 1 Side, Backsplash

ITEM # _____

MODEL # _____

NAME # _____

SIS # _____

AIA # _____



588524 (MBGGBBHOPO) 4-Burner gas Top, one-side operated with backsplash

Short Form Specification

Item No. _____

Unit constructed according to DIN 18860_2 with 20 mm drop nose top. Internal frame for heavy duty sturdiness in stainless steel. 2 mm top in 1.4301 (AISI 304). Flat surface construction, easily cleanable. THERMODUL connection system enables seamless worktop when units are connected and avoids soil penetrating. 4 gas burners with optimized combustion, flame failure device, thermocouple safety hand valve and protected pilot flame. Triple ring "flower" flame burners with anti-clogging design. Manual gas valves allow precise flame intensity control. Large pan support in cast iron with long center fins for various pan sizes. Deep flat spillage tray with rounded corners and drain hole. Metal knobs with embedded hygienic silicon "soft" grip enable easier handling and cleaning.

IPX4 water resistant certification.

Configuration: One side operated top with backsplash. The base needs to be supplied by the factory. Please include appropriate base.

Main Features

- Flame failure device on each burner protects against gas leakage when accidental extinguishing of the flame occurs.
- Large sized pan support in cast iron with long center fins to allow the use of the largest down to the smallest pans.
- Manual gas valves allow precise control of the flame intensity between high and low positions.
- Pans can easily be moved from one area to another without lifting.
- All major components may be easily accessed from the front.
- THERMODUL connection system creates a seamless work top when units are connected to each other thus avoiding soil penetrating vital components and facilitating the removal of units in case of replacement or service.
- Metal knobs with embedded hygienic "soft-touch" grip for easier handling and cleaning. The special design of the controls prevents infiltration of liquids or soil into vital components.
- Burners with optimized combustion. Triple ring flower flame burners with anti-clogging design.
- Patented Flower Flame burners that adjust to the size and form of the cookware (Patent EP2708813B1 and related family).

Construction

- Each burner equipped with thermocouple safety hand valve and protected pilot flame.
- 2 mm top in 1.4301 (AISI 304).
- Flat surface construction with minimal hidden areas to easily clean all surfaces
- Internal frame for heavy duty sturdiness in 1.4301 (AISI 304).
- IPX4 water protection.
- Unit constructed according to DIN 18860_2 with 20 mm drop nose top.

Optional Accessories

- Connecting rail kit for appliances with backsplash, 850mm PNC 912498
- Portioning shelf, 800mm width PNC 912526
- Portioning shelf, 800mm width PNC 912556
- Folding shelf, 300x850mm PNC 912579
- Folding shelf, 400x850mm PNC 912580
- Fixed side shelf, 200x850mm PNC 912586
- Fixed side shelf, 300x850mm PNC 912587
- Fixed side shelf, 400x850mm PNC 912588
- Back panel, 800x700mm, for units with backsplash PNC 913013
- Endrail kit, flush-fitting, with backsplash, left PNC 913115
- Endrail kit, flush-fitting, with backsplash, right PNC 913116
- Endrail kit (12.5mm) for thermaline 85 units with backsplash, left PNC 913206

APPROVAL: _____



Experience the Excellence
www.electroluxprofessional.com



Electrolux
PROFESSIONAL

Modular Cooking Range Line thermaline 85 - 4-Burner Gas Top, 1 Side, Backsplash

- Endrail kit (12.5mm) for thermaline 85 units with backsplash, right PNC 913207
- U-clamping rail for back-to-back installations with backsplash (to be ordered as S-code) PNC 913226
- Insert profile, d=850mm PNC 913231
- Kit LPG nozzles for 4 burner (7 kW) gas 30/31 PNC 913286
- Stainless steel side panel (12,5mm), 850x400mm, left side, wall mounted PNC 913632
- Stainless steel side panel (12,5mm), 850x400mm, right side, wall mounted PNC 913633
- Stainless steel side panel (12,5mm), 850x400mm, flush-fitting, left side, wall mounted PNC 913634
- Stainless steel side panel (12,5mm), 850x400mm, flush-fitting, right side, wall mounted PNC 913635
- Wall mounting kit top - TL85/90 - Factory Fitted PNC 913652
- Solid top plate for 7kW and 10kW open burner PNC 913674



Modular Cooking Range Line
thermaline 85 - 4-Burner Gas Top, 1 Side, Backsplash

The company reserves the right to make modifications to the products without prior notice. All information correct at time of printing.

2026.05.27

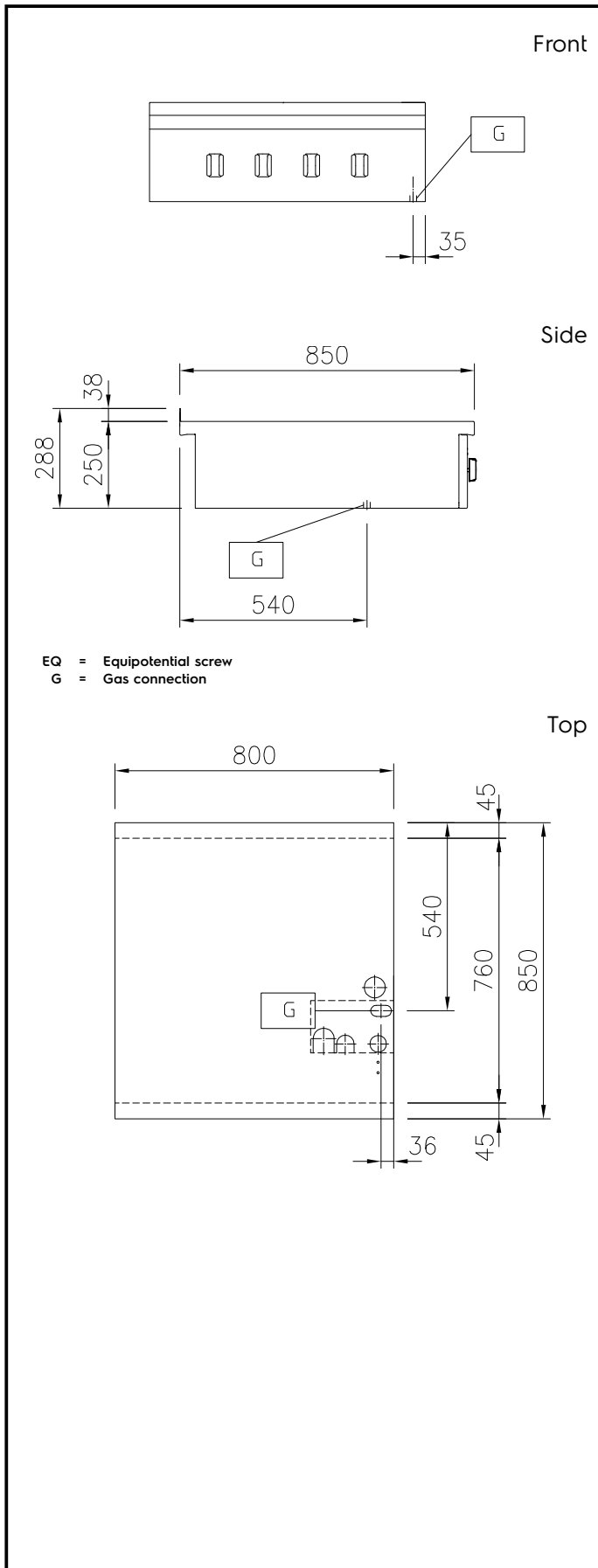

Gas

Gas Power:	28 kW
Gas Type Option:	
Gas Inlet:	1/2"

Key Information:

External dimensions, Width:	800 mm
External dimensions, Depth:	850 mm
External dimensions, Height:	250 mm
Net weight:	65 kg
Configuration:	One-Side Operated;Top
Front Burners Power:	7 - 7 kW
Back Burners Power:	7 - 7 kW
Back Burners Dimension - mm	Ø 70 Ø 70
Front Burners Dimension - mm	Ø 70 Ø 70